

FALCO

FK150

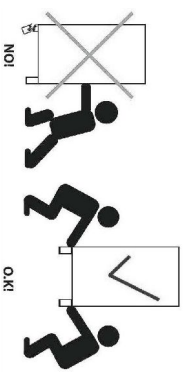
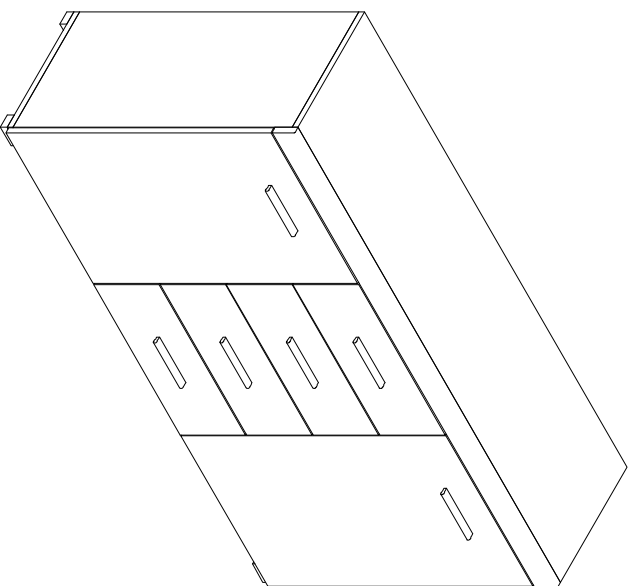

31.6.2017

- (D)** Montageanleitung
- (FR)** Notice de montage
- (NL)** Handleiding voor de montage
- (CZ)** Montážní návod
- (HU)** Szerelési útmutató
- (TR)** Montaj talimatı
- (GB)** Assembly Instructions
- (IT)** Istruzioni di montaggio
- (PL)** Instrukcja montażu
- (SK)** Návod na montáž
- (RO)** Instrucțiunile de montaj
- (RU)** Инструкции по монтажу

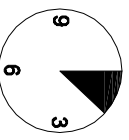

20 min.

1

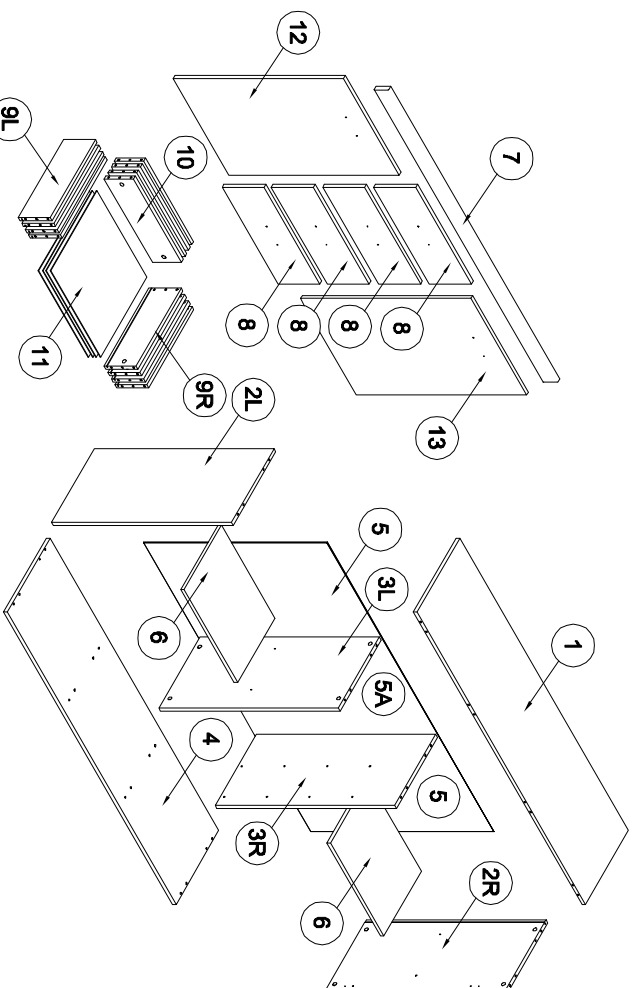

ZC x10	Y x6	W x6	YA x12	PC x4	NA x8	ND x24	C x36	Z x36
B x36	A x52	RPS x4	RC x4	H x8	NB x24	N x26	X x10	

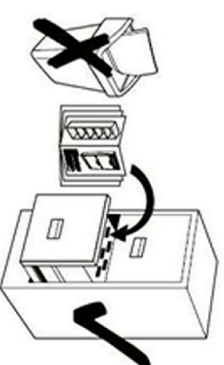
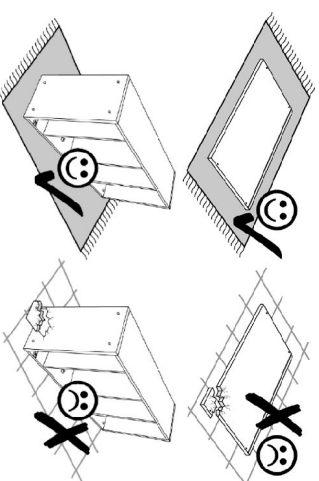

2

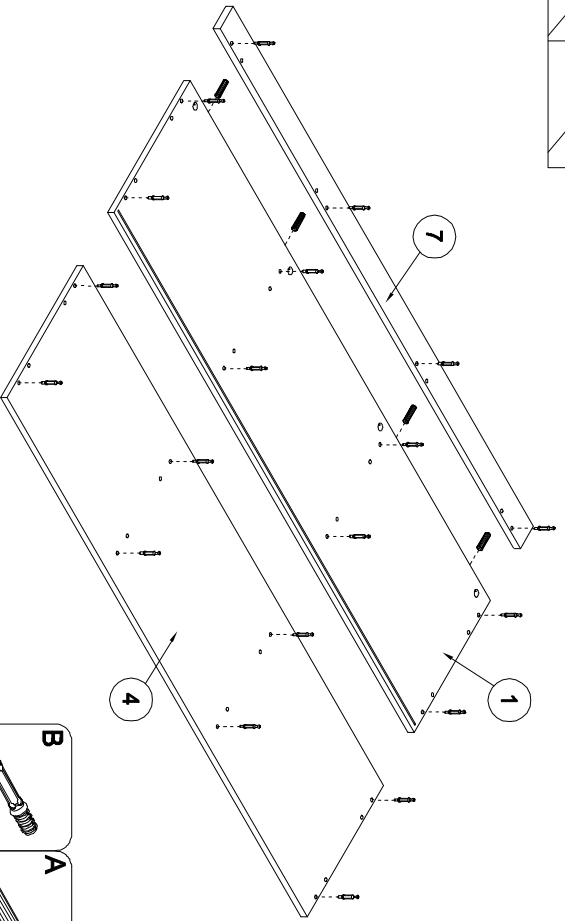
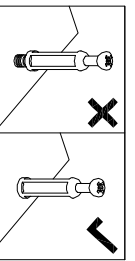

- B** X20
- A** 8x32 X4

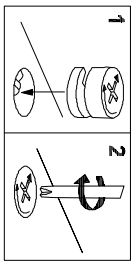

3

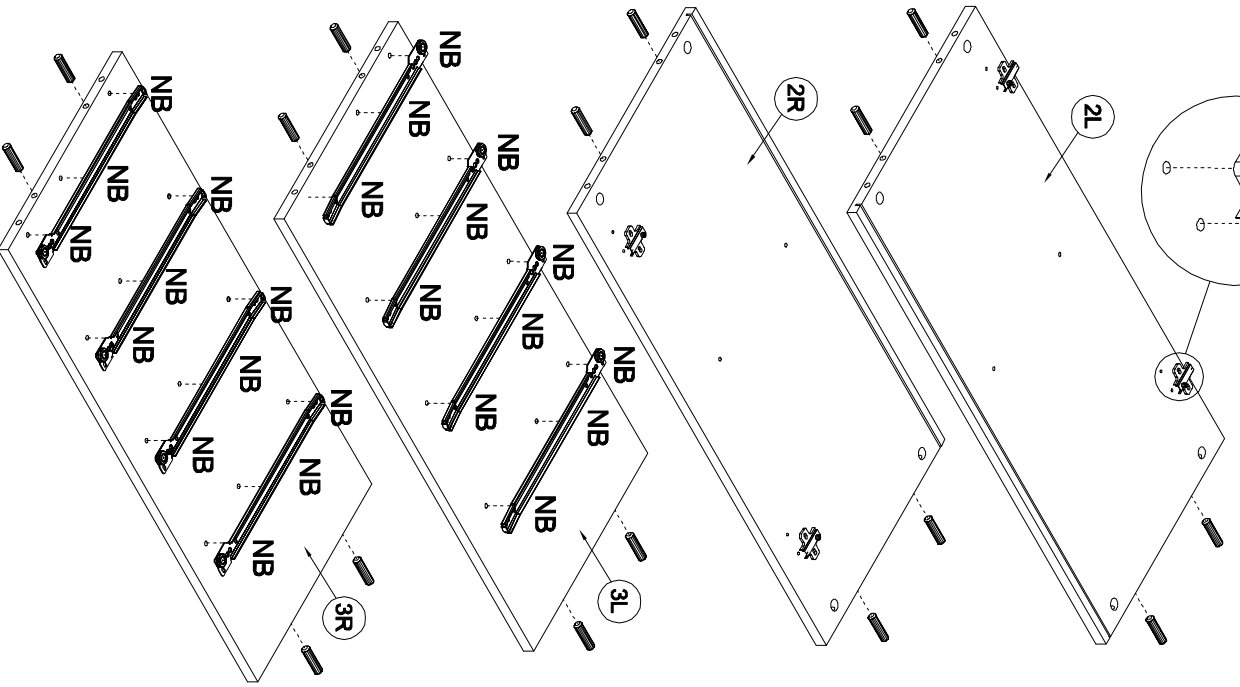
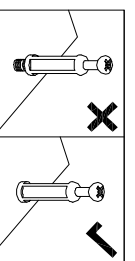

- C** X4
- Z** X4

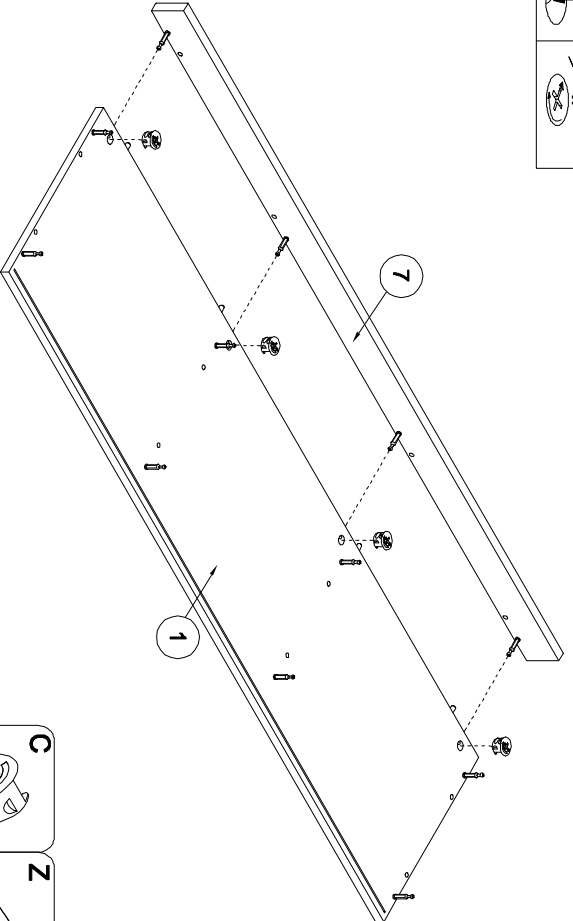



4

- RPS** X4
- A** 8x32 X4
- RC** X16
- H** 6.5x13 X4
- NB** 3.5x13 X8
- NB** 3.5x13 X24

5

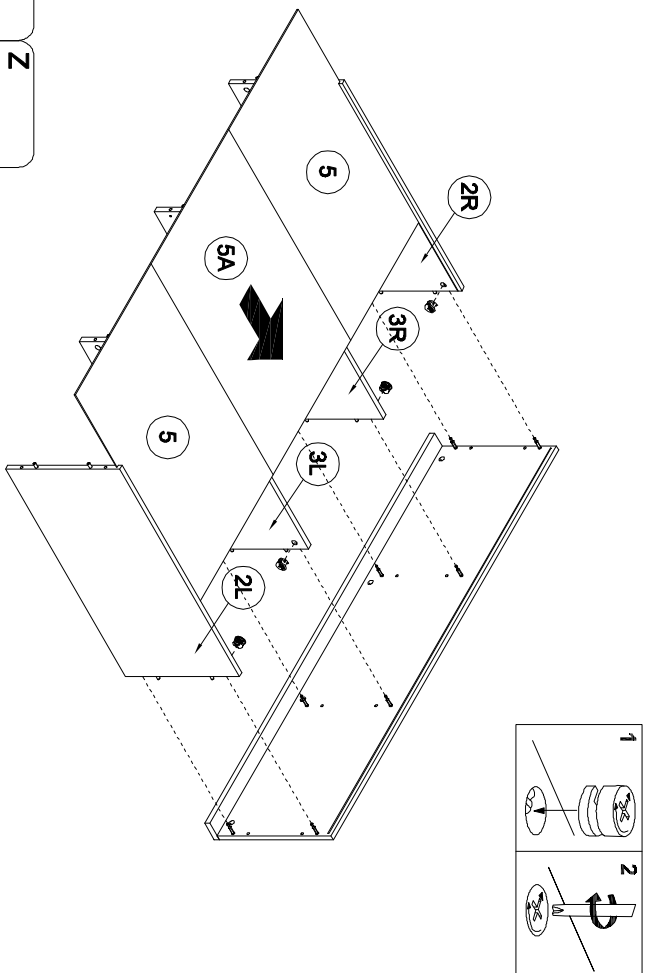

6



- C  x8
- Z  x8

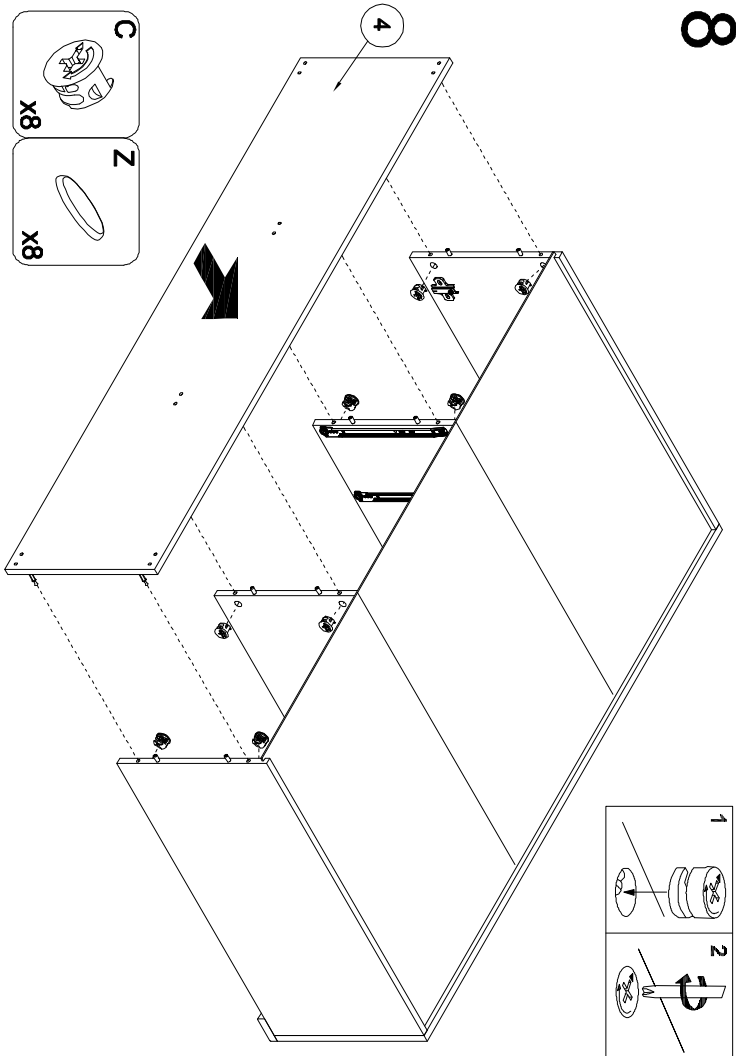



8

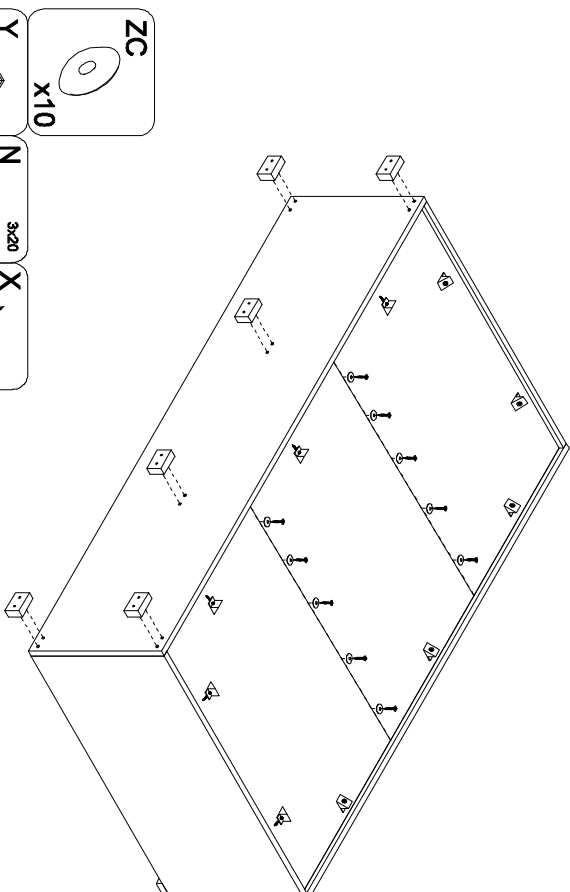

- C  x8
- Z  x8





7

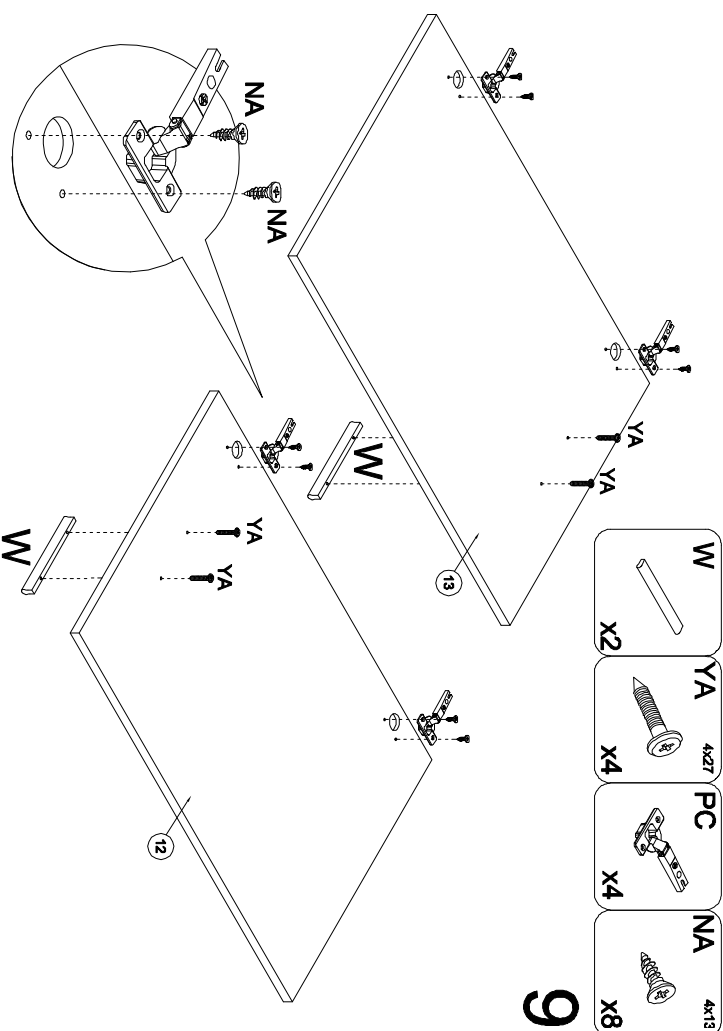

- ZC  x10
- Y  x6
- N  3x20 x10
- X  x10

9



- W  x2
- YA  4x27 x4
- PC  x4
- NA  4x13 x8

10

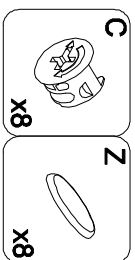
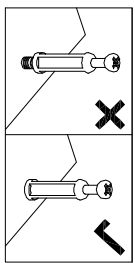
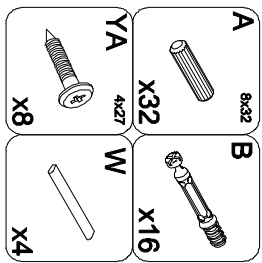
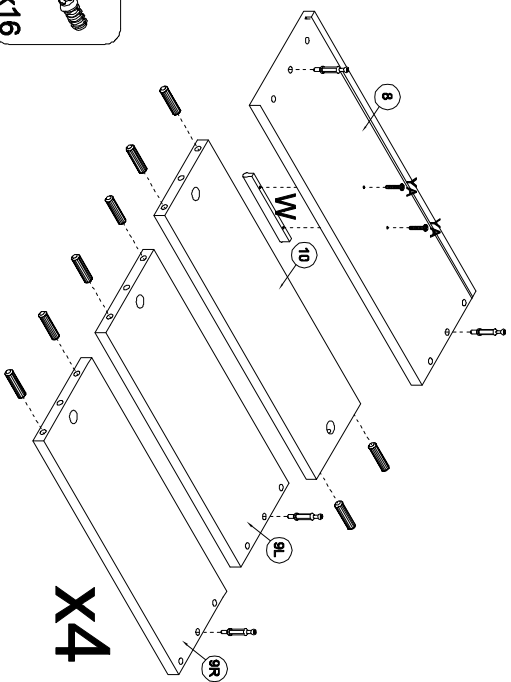

11

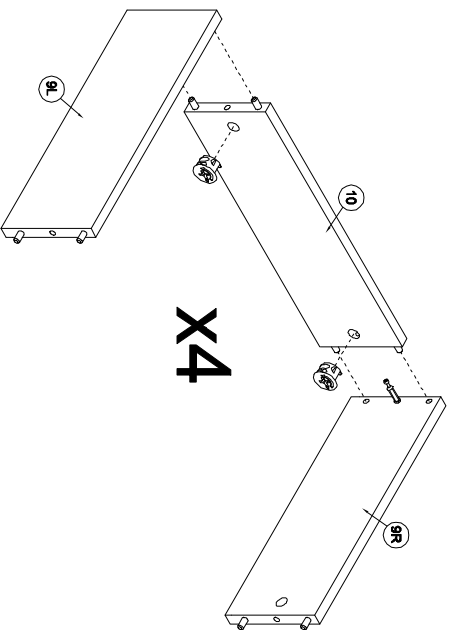

12

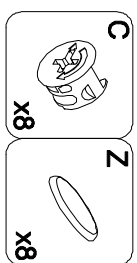
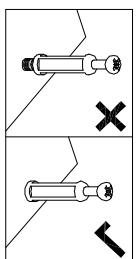
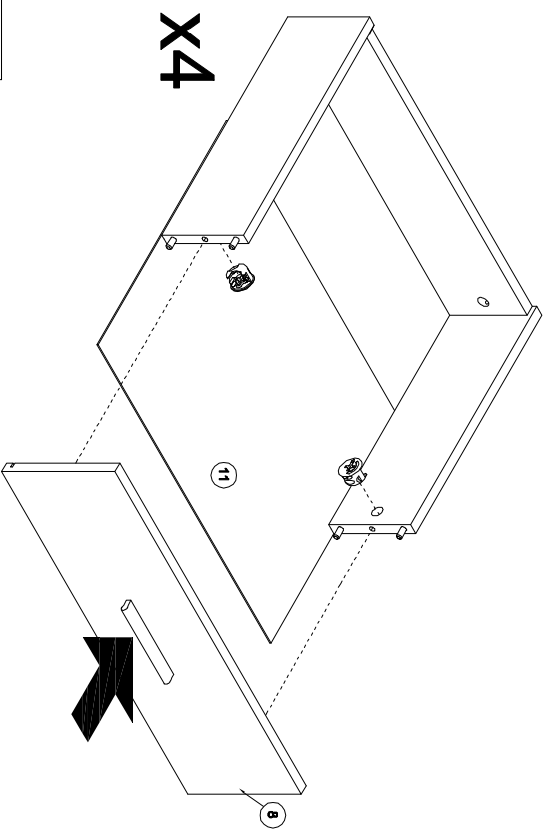

13

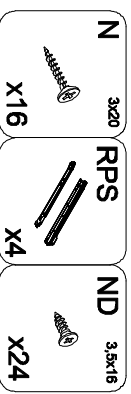
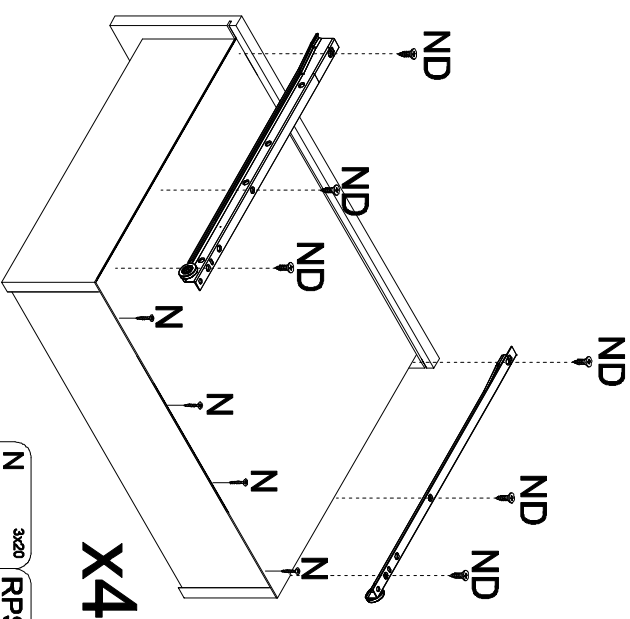

14

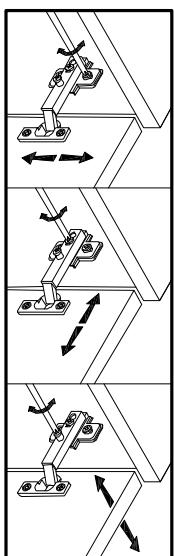
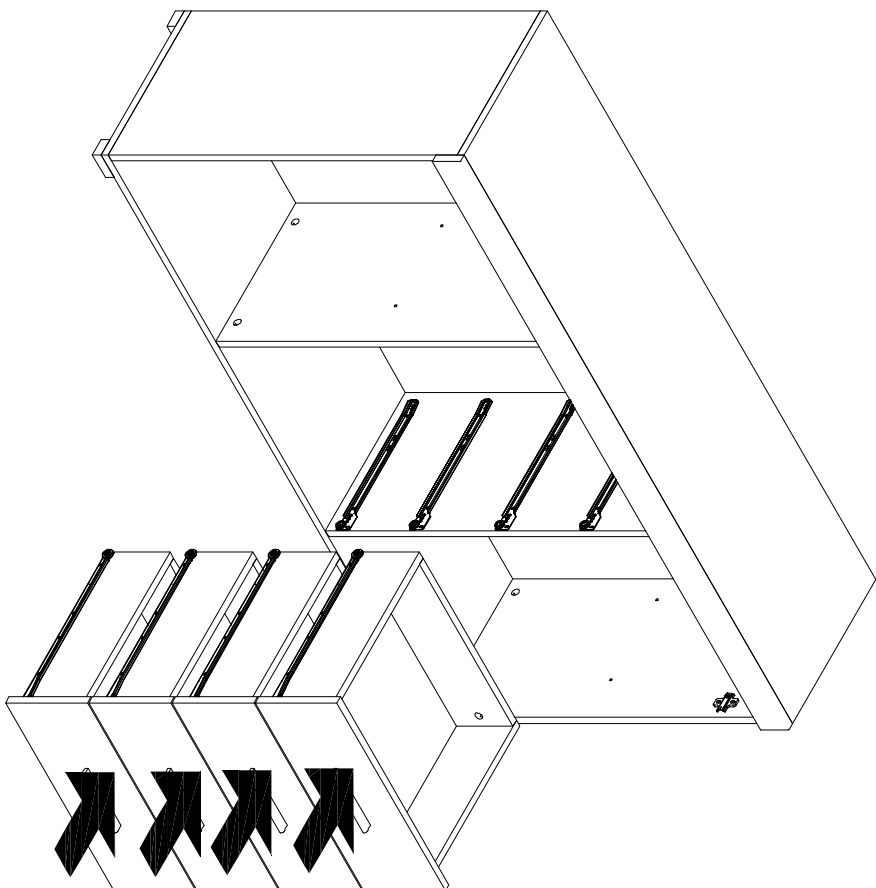

15

